

Mechatronics

SNR Mechatronics

	702
■ Customized Motion Sensing	702
■ Development and Production	703
■ Production	703
■ Engineering	704
■ Magnetic encoders	704
■ Sensing elements	704
■ ASB® - Active Sensor Bearing	705
■ SLE - Sensorline Encoder	705
■ Radial sensor	706
■ Motor racing: Pescarolo Sport	706
■ Brushless motor	707

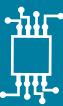

SNR Mechatronics – Customized Motion Sensing

■ SNR Mechatronics was created in 2002 to develop the SNR group's mechatronic activities. The division is seen as a pioneer in sensor bearings.

SNR Mechatronics proposes solutions, either integrated or not for bearings involved in speed or position sensing.

We were the first to introduce a sensor bearing for motorcar wheels integrating a magnetic encoder and an active sensor.

ASB is a major innovation which has now become a standard nearly adopted by all automotive manufacturers in Europe and Japan.

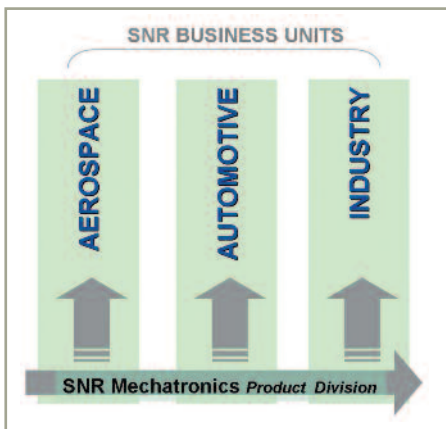
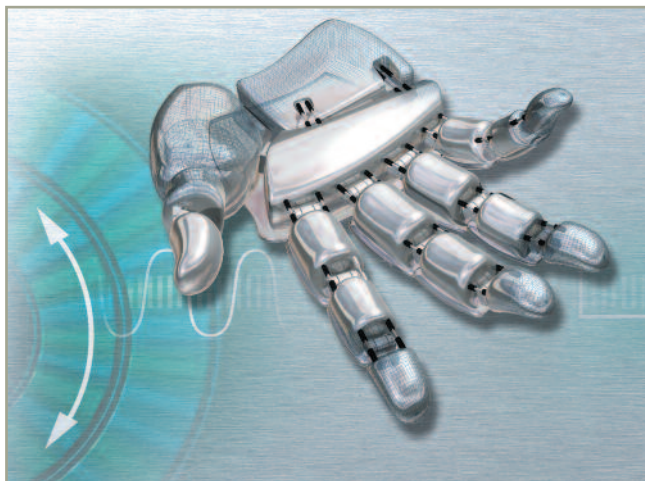

Thanks to our experience in high-precision applications, we have developed and manufactured mechatronic products for more than 15 years. This know-how, together with high professionalism in Automotive, Aerospace and Industrial sectors lead us to offer "tailor-made" products for full satisfaction of our clients.

Today, our ambition is to propose specific solutions for each demand in our activity sectors.

Development and Production

■ SNR Mechatronics is based on a unique magnetising process (magnetic encoder) and perfectly adapted magnetic sensing technologies (magneto-resistors, Hall-effect elements, SNR-proprietary ASIC, "Application-Specific Integrated Circuit") to develop specific applications. We can deliver high resolution signals for speed measurement, angle or direction sensing, and reference pulse generation for short-distance rotation or linear measurements.



Most of the new developments are specific and require fine studies which involve our basic technology. SNR Mechatronics possesses all resources required for designing these solutions: design and simulation tools, test laboratories and prototype processes.

Our specialists in each one of the Automotive, Industrial or Aerospace domains are fully liable for the management of the mechatronics projects from pre-design studies to serial-production. By combining SNR Mechatronics's expertise with the know-how of all SNR divisions, we ensure reliable, strict and economical studies for you.

Production

■ The SNR production sites integrate sophisticated production lines and test and monitoring equipment for our mechatronics products. SNR uses electronic components from the market leaders.

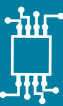
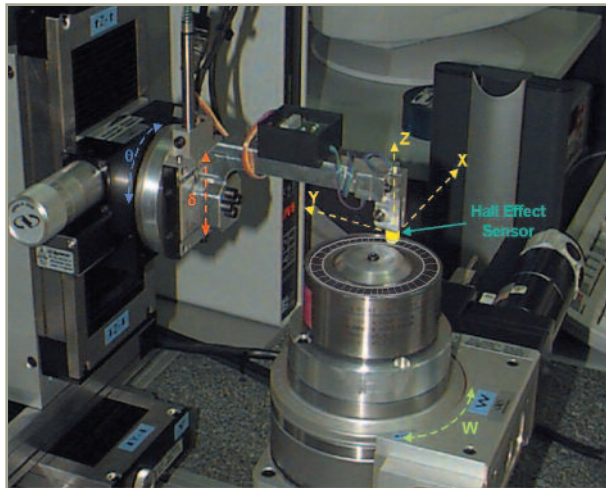

Engineering

■ We have a deep experience and strong know-how in displacement/motion sensors, magnetism, microelectronics, software and mechanical integration. Based on our clients' needs and activity field, our experts from the various company's sectors control the project from the beginning to the end.

We develop high competence in magnetic sensing: writing and reading magnetic data from an angular or linear encoder is the basic technology of our solutions.

This technology delivers a high resolution output signal for angular rotation rate and direction, and reference pulse generation.

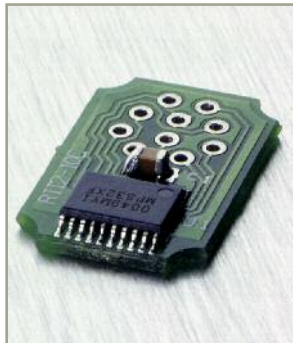

Magnetic encoders

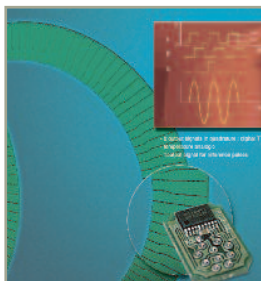

■ The use of magnetic data supports built from elastomer base magnetic materials lead us to develop a unique know-how in simulation, materials and system design, as well as writing and final inspection processes.

Magnetic encoding is ensured either in single track mode, as in the ASB product, or in bi-track which then integrates a much richer information base, whenever the SNR-proprietary ASIC reading head MPS40S is used.

Sensing elements

■ The SNR-proprietary Hall effect ASIC, MPS40S, is designed for simultaneous reading of 2 encoded magnetic tracks. It controls two quadratic signals on one of the tracks and one or more reference pulses on the other. Its main property lies in its capacity to interpolate up to 40 times the excitation magnetic encoding resolution. Therefore, a multipolar target with 32 pairs of poles can generate up to 1,280 pulses/revolution (5,120 fronts).

Temperature compensation (-40/+125°C) is integrated, as well as automatic gap variation compensation between ASIC and magnetic target during utilisation.

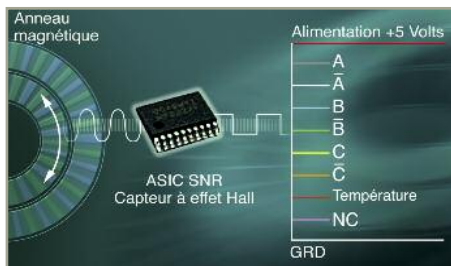

ASB® - Active Sensor Bearing

■ ASB® is an SNR registered trademark pertaining to the innovative wheel speed sensor bearing technology, an application which has been in high volume automobile production since 1997.

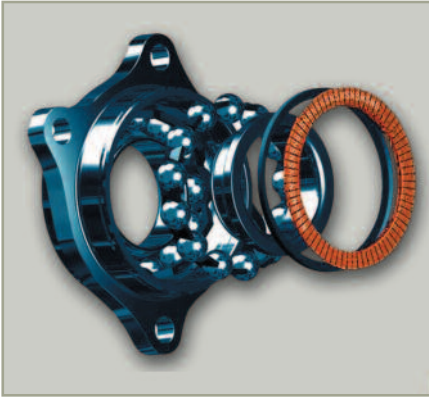

ASB® is a wheel bearing incorporating a rotating magnetic encoder seal, able to activate a tiny active sensor located close by.

The multipole magnetic encoder is made up of an elastomer-based anisotropic magnetic material, saturated by means of a specific magnetisation process. The active sensor which integrates a Hall effect sensor and a magneto-resistant element is attached to the bearing by a clip or more conventionally screwed to the Knuckle.

Any type of modern wheel bearing may be fitted with ASB technology

With the quality of signals provided (zero speed, rotation direction, etc.) through ASB®, SNR has opened up new possibilities for automobile designers.

An example of the type of products SNR Mechatronics is able to design for you is SLE.

SLE - Sensorline Encoder

■ **Sensor Line Encoder:** a high resolution increment encoder integrated in a bearing.

By integrating a by-track magnetic encoder and an SNR-proprietary ASIC, MPX32X (first generation SNR ASIC) in a bearing, the Sensor Line Encoder provides reliable measurements in a very compact envelope. It operates as a bearing, easily integrated into a mechanical environment, and benefits from SNR's experience in bearing instrumentation.

Our company's experience also guarantees bearing precision and durability: two vital conditions for reliable measurements.

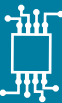

Radial sensor

■ SNR developed a high resolution radial speed sensor with rotating direction indication (Power supply in 5V or in 8-30V. Interfaces: Push/pull 15mA (Standard) and optionally RS422, Push/Pull 50mA, or Open Drain).

These sensors operate with radial magnetic encoders available in-house at SNR, in various diameters.

On request, SNR Mechatronics can develop specific encoders tailored to the application, either in specific diameters or in terms of the number of pairs of poles.

For an encoder with 48 pairs of poles, the sensor can deliver the following information: 48, 96, 192, 384, 768, 1,536 periods/channel/revolution.

Depending on the operating electronic circuitry, you can obtain information on rotational speed, relative displacement and rotating direction.

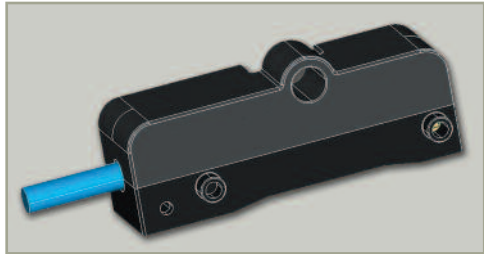

Motorcar racing: Pescarolo Sport

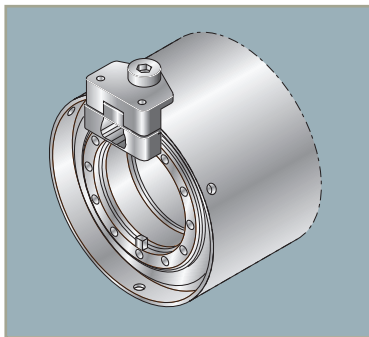

■ The flexibility of our technology enabled Pescarolo Sport to equip its Le Mans racing cars with high resolution wheel speed sensors: a vital information for measurement of the car behaviour during the race, and for timely intervention as required. As is often the case, technologies developed for racing will then be applied to daily industrial designs.



Brushless motor

■ The by-track magnetic encoding technology associated with the SNR-proprietary ASIC, MPS40S, allows efficient control of brushless DC motors (DLDC). In fact, the track which generated the reference pulses will ensure switching control whereas the "high resolution" track allows torque variation control (torque ripple).

The SNR technology is highly reputed for compact design. In fact, the optimised magnetic encoder is preferably integrated to a bearing, without changing its external dimensions.

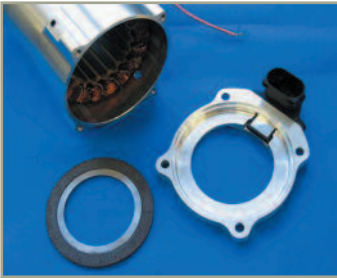

ASIC integrates signal processing functions which appreciably reduce the sensor's footprint.

