

Bearing technology

Bearing characteristics	38
■ Bearing design	38
■ Materials and surface treatments	39
<i>Knowledge of materials and monitoring of their quality</i>	39
<i>Materials and surface treatments</i>	39
<i>Heat treatment</i>	40
■ Bearing manufacture	42
<i>Shaping the bearing rings</i>	42
<i>The bearing finish</i>	42
<i>Standard manufacturing process</i>	43
Bearing component variants	44
■ Inner ring	44
<i>Tapered bore</i>	44
<i>Special corners</i>	45
■ Definitions	46
■ Other ring variants	48
■ Cage	49
<i>Materials</i>	49
<i>Centering</i>	50
<i>Choice of a special cage</i>	50
Shielding and sealing	52
■ Shielding and sealing devices external to the bearing	53
■ Other types of seals	54

Bearing characteristics

Bearing design

The continuous improvement in the performance of SNR bearings and their service life relies upon constant technological progress in three areas: design, materials and manufacture.

■ Standard bearing

The aim of the design is to determine the internal geometry of the bearing while adhering to a standard envelope. The bearing must meet the largest possible number of applications while achieving the best cost/performance compromise.

The optimization effort focuses on the bearing components: rolling elements (number, dimensions, profile), bearing raceways (profile), cage (material, design), and the seals, taking into account:

- the mechanical strength of the materials
- the manufacturing means
- the cost

■ Special bearing

When it is technically necessary and economically possible, the SNR bearing can provide a more comprehensive rotation function, either through a specially developed capability, or by integrating a set of functions associated with the rotation function: attachment, shielding, lubrication, power transmission, measurement, etc.

The adaptation of these bearings to the application brings substantial gains through technical and industrial optimization. It allows, among other things, an original design to be protected and more generally to increase the performance of your products. We advise you to contact your SNR representative to investigate this highly effective approach.

Materials and surface treatments

→ Knowledge of materials and monitoring of their quality

SNR carries out in-depth research into the endurance of steels in collaboration with steel manufacturers. For each grade of steel we have defined extremely precise and stringent specifications that concern the following points:

- the method of steel production
- the chemical composition
- the hardness, quenching hardenability
- the macrostructure and macrographic soundness
- the microstructure and micro-cleanliness
- the endurance
- the product presentation
- the reception and inspection conditions

The verification of the material is performed by metallographic and spectrographic inspection, completed by bench tests.

This section details the most currently used materials and surface treatments. Your SNR contacts are at your disposal to study with you the solutions to meet your specifications.

→ Materials and surface treatments

■ Applications standard

Requirements	Proposals														
<ul style="list-style-type: none"> ▶ Excellent resistance to fatigue and wear. ▶ Can achieve homogenous hardness throughout. 	<ul style="list-style-type: none"> ▶ 100Cr6 (AFNOR) high-carbon chromium steel This very commonly used steel displays many advantages: cleanliness (absence of inclusions), quenchantability without carburization, heat treatment method flexibility. Our continuous quality monitoring of materials has enabled us to substantially increase the endurance of this type of steel. 														
	<table style="width: 100%; border-collapse: collapse;"> <tr> <td style="width: 60%; vertical-align: top;">▶ Chemical composition</td> <td style="vertical-align: top;"> <table style="width: 100%; border-collapse: collapse;"> <tr> <td style="width: 10%;"></td> <td style="width: 10%;">C</td> <td style="width: 80%;">from 0.98 to 1.10 %</td> </tr> <tr> <td></td> <td>Si</td> <td>from 0.15 to 0.35 %</td> </tr> <tr> <td></td> <td>Mn</td> <td>from 0.25 to 0.45 %</td> </tr> <tr> <td></td> <td>Cr</td> <td>from 1.30 to 1.60 %</td> </tr> </table> </td> </tr> </table>	▶ Chemical composition	<table style="width: 100%; border-collapse: collapse;"> <tr> <td style="width: 10%;"></td> <td style="width: 10%;">C</td> <td style="width: 80%;">from 0.98 to 1.10 %</td> </tr> <tr> <td></td> <td>Si</td> <td>from 0.15 to 0.35 %</td> </tr> <tr> <td></td> <td>Mn</td> <td>from 0.25 to 0.45 %</td> </tr> <tr> <td></td> <td>Cr</td> <td>from 1.30 to 1.60 %</td> </tr> </table>		C	from 0.98 to 1.10 %		Si	from 0.15 to 0.35 %		Mn	from 0.25 to 0.45 %		Cr	from 1.30 to 1.60 %
	▶ Chemical composition	<table style="width: 100%; border-collapse: collapse;"> <tr> <td style="width: 10%;"></td> <td style="width: 10%;">C</td> <td style="width: 80%;">from 0.98 to 1.10 %</td> </tr> <tr> <td></td> <td>Si</td> <td>from 0.15 to 0.35 %</td> </tr> <tr> <td></td> <td>Mn</td> <td>from 0.25 to 0.45 %</td> </tr> <tr> <td></td> <td>Cr</td> <td>from 1.30 to 1.60 %</td> </tr> </table>		C	from 0.98 to 1.10 %		Si	from 0.15 to 0.35 %		Mn	from 0.25 to 0.45 %		Cr	from 1.30 to 1.60 %	
		C	from 0.98 to 1.10 %												
	Si	from 0.15 to 0.35 %													
	Mn	from 0.25 to 0.45 %													
	Cr	from 1.30 to 1.60 %													
<table style="width: 100%; border-collapse: collapse;"> <tr> <td style="width: 40%; vertical-align: top;">▶ Mechanical characteristics</td> <td style="vertical-align: top;"> <table style="width: 100%; border-collapse: collapse;"> <tr> <td style="width: 30%;">Coefficient of expansion</td> <td style="width: 70%;">: C1=12 x10⁻⁶ mm/mm/°C</td> </tr> <tr> <td>Modulus of elasticity</td> <td>: E = 205 000 N/mm²</td> </tr> <tr> <td>Poisson ratio</td> <td>: η = 0.3</td> </tr> </table> </td> </tr> </table>	▶ Mechanical characteristics	<table style="width: 100%; border-collapse: collapse;"> <tr> <td style="width: 30%;">Coefficient of expansion</td> <td style="width: 70%;">: C1=12 x10⁻⁶ mm/mm/°C</td> </tr> <tr> <td>Modulus of elasticity</td> <td>: E = 205 000 N/mm²</td> </tr> <tr> <td>Poisson ratio</td> <td>: η = 0.3</td> </tr> </table>	Coefficient of expansion	: C1=12 x10 ⁻⁶ mm/mm/°C	Modulus of elasticity	: E = 205 000 N/mm ²	Poisson ratio	: η = 0.3							
▶ Mechanical characteristics	<table style="width: 100%; border-collapse: collapse;"> <tr> <td style="width: 30%;">Coefficient of expansion</td> <td style="width: 70%;">: C1=12 x10⁻⁶ mm/mm/°C</td> </tr> <tr> <td>Modulus of elasticity</td> <td>: E = 205 000 N/mm²</td> </tr> <tr> <td>Poisson ratio</td> <td>: η = 0.3</td> </tr> </table>	Coefficient of expansion	: C1=12 x10 ⁻⁶ mm/mm/°C	Modulus of elasticity	: E = 205 000 N/mm ²	Poisson ratio	: η = 0.3								
Coefficient of expansion	: C1=12 x10 ⁻⁶ mm/mm/°C														
Modulus of elasticity	: E = 205 000 N/mm ²														
Poisson ratio	: η = 0.3														
<ul style="list-style-type: none"> ▶ 100 Cr6 vacuum re-melted when a gain in performance in a given envelope is absolutely necessary. ▶ XC68 for bearings produced from steel strip. 															

Bearing characteristics *(continued)*

■ Special applications

Requirements	Proposals
<ul style="list-style-type: none"> ▶ High resistance to fatigue and wear. ▶ High impact strength at core. 	<ul style="list-style-type: none"> ▶ 100Cr6 steel with localized hardening of the bearing raceways and working surfaces (e.g. contact faces), while the core of the part remains in the initial metallurgical condition. ▶ Case-hardening steels.
<ul style="list-style-type: none"> ▶ Resistant to high temperatures. 	<ul style="list-style-type: none"> ▶ 100Cr6 steel with stabilization heat treatment. <p>For bearings made in limited quantities:</p> <ul style="list-style-type: none"> ▶ E80DCV40 (AFNOR) or M50 (AISI) "tool" steel, produced and cast in vacuum when identical hardness at core and surface is necessary; ▶ High-temperature case-hardening steels; ▶ Nitriding steels if the bearings are subject to moderate loads.
<ul style="list-style-type: none"> ▶ Improvement in the wear resistance of the bearing external surfaces. 	<ul style="list-style-type: none"> ▶ Anti-wear surface treatments such as phosphatizing, hard chrome plating, black oxidizing, or others, depending on specifications.
<ul style="list-style-type: none"> ▶ Improvement in corrosion resistance. 	<ul style="list-style-type: none"> ▶ Surface treatments such as electrolytic zinc or others depending on specifications. ▶ Stainless steels.
<ul style="list-style-type: none"> ▶ Improvement in fretting corrosion resistance between the shaft or housing and the bearing. 	<ul style="list-style-type: none"> ▶ Surface treatments such as copper or hard chrome plating on the external surfaces of the bearing.
<ul style="list-style-type: none"> ▶ Lubrication in very low quantities or lubrication by the surrounding environment (petrol, diesel, etc.). 	<ul style="list-style-type: none"> ▶ Use of ceramic balls. ▶ Self-lubricating surface treatments such as silver + molybdenum bisulphide or others for lightly loaded bearings.
<ul style="list-style-type: none"> ▶ Improvement in contamination resistance. 	<ul style="list-style-type: none"> ▶ The collaboration between SNR and the steel manufacturers came up with the development of a bearing steel that is less sensitive to contamination. This steel, which has a special chemical composition and microstructure, requires an appropriate heat treatment. This new material reconciles high surface hardness to resist wear with matrix ductility which reduces the risk of cracking, while maintaining good dimensional stability.

➔ Heat treatment

The principle of bearing steel heat treatment is to give a martensitic structure to get:

- the required hardness (62 HRc approx.),
- the fatigue resistance,
- and the dimensional stability,

necessary to cover the majority of applications.

It requires a pre-hardening austenitic phase at high temperature above the transformation point.

Types of treatments

SNR has defined several types of standard hardening of 100 Cr6 steel adapted to the requirements of the application.

For example:

Deep martensitic hardening which, by means of judiciously chosen tempering operations, gives perfectly controlled compromises between the ability to withstand Hertz stresses and dimensional stability, and therefore maintaining the geometric precision of the bearings under the most general service conditions.

Surface hardening of the raceways and working surfaces (e.g. contact faces), while the core of the part remains in the initial metallurgical condition.

Deep bainitic hardening which gives a good hardness / toughness compromise in the mass and on the raceways.

Dimensional stability of the steel and influence on the bearing clearance

Hardened martensitic steel always contains a percentage of residual austenite that limits its use to a temperature range of approximately -20°C (-4°F) to $+150^{\circ}\text{C}$ (302°F).

At low temperature

hardening continues and the residual austenite (γ) transforms into secondary martensite (α') and increases the specific volume of the steel.

At high temperature

the transformation of residual austenite ($\gamma \rightarrow \alpha$) brings an increase in the specific volume of the steel (1)

the depletion of martensite through the release of carbon (ϵ) brings a reduction in the specific volume of the steel (2)

These two irreversible phenomena only compensate for one another to a very

limited extent. The bearing undergoes a dimensional variation whose amplitude and speed depend on the holding time at its operating temperature, which leads to a modification in the shaft-bearing and bearing-housing fits and therefore the operating clearance.

Beyond the normal temperature of $+150^{\circ}\text{C}$ ($+302^{\circ}\text{F}$), the dimensional variation of the steel is no longer considered negligible, and bearings used will have to undergo a special stabilization heat treatment that restores dimensional variations to a level compatible with the applications.

→ Consult SNR.

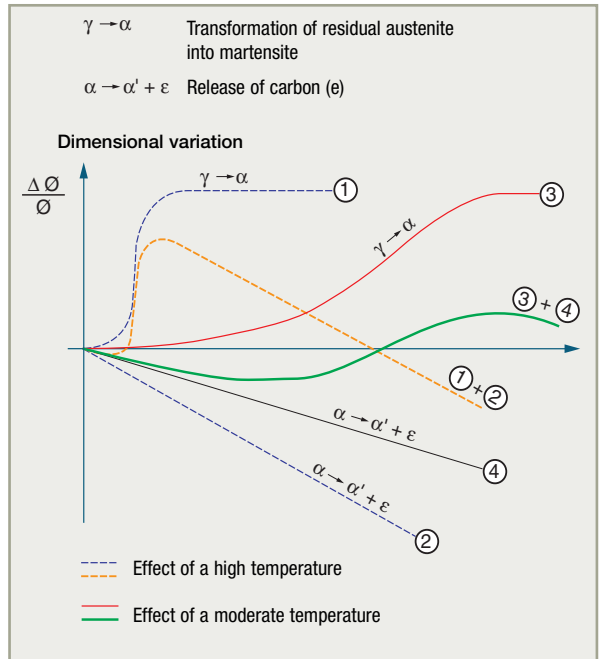

Bearing characteristics *(continued)*

Bearing manufacture

SNR has developed an efficient production quality insurance system subtended by operator control and continuous process monitoring (SPC). This system ensures optimum quality of our products over time by mastering all the component process (means, methods, labor, environment and material).

→ Shaping the bearing rings

The bearing rings are shaped by:

- turning,
- deformation (drop forging, rolling, drawing).

The deformation of the metal produces a fiber orientation that is parallel to the raceway, increasing fatigue strength and therefore endurance. The development of deformation techniques is associated with the best cost-performance compromise.



→ The bearing finish

The finishing operations determine the surface quality of the contacting elements, which is fundamental for stress resistance and lubrication.

■ Quality is monitored at three levels:

- ▶ **Geometry:** shapes, micro-geometry of contact surfaces (curves, profiles, etc.)

With roller bearings, the distribution of forces on the roller-ring interface is not uniform and depends upon:

- the applied loads,
- the misalignments imposed on the bearing,
- the contacting profiles.

The production of optimized profiles for roller bearings:

- improves load distribution on the roller contact line
- avoids having excess stresses at the roller edges.



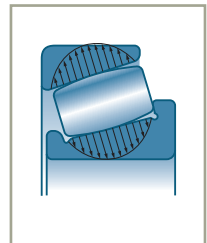
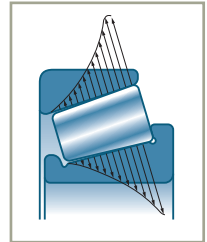

With ball bearings, adapting the race curvatures to the operating conditions enables the bearing geometry to be optimized, bringing a reduction in the friction torque and an increase in service life.

- ▶ **Surface roughness**

- ▶ **Metallurgical condition:** the machining method has to take in account the surface metallurgical qualities

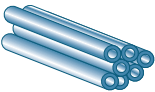

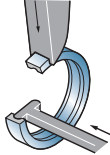
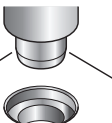
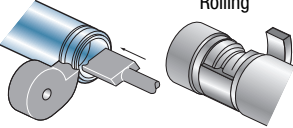
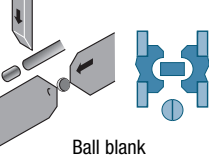
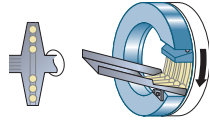
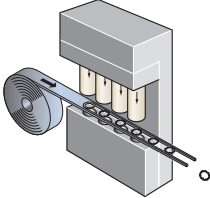
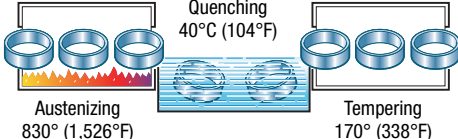
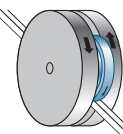
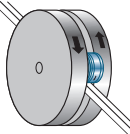
→ **Standard manufacturing process**

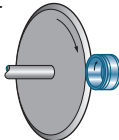
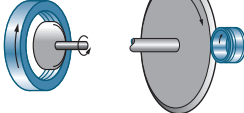
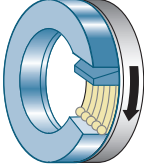
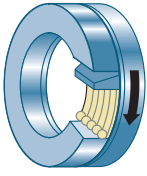
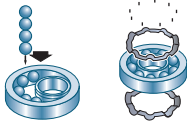
Operation	Rings	Rolling elements	Cage
Material	<p>Tubes, bars</p> 	<p>Wire</p> 	<p>Coil strips</p> 
Shaping	<p>Turning</p>  <p>Forging</p>  <p>Rolling</p> 	<p>Cutting and cold heading</p>  <p>Ball blank</p> 	<p>Drawing steel cages</p>  <p>Molding of plastic cages Turning of solid metal cages</p>
Heat treatment	 <p>Austenizing 830° (1,526°F)</p> <p>Quenching 40°C (104°F)</p> <p>Tempering 170° (338°F)</p>		
Finition	<p>Finishing</p> <p>Outer ring</p>  <p>Inner ring</p>  <p>Grinding wheel</p>  <p>Drive cylinder</p>  <p>Honing</p> 	<p>Grinding on grinding wheel</p>  <p>Lapping with abrasive paste between 2 plates</p> 	
Assembly of the bearing	<p>Washing, Marking, Final inspection, Packing</p> 		

Bearing component variants

Inner ring

This chapter describes the specific manufacturing characteristics than can modify the standard bearing or bearings designed for a specific application. Some of these modifications are standard, others can be carried out on request.

→ Tapered bore

■ Tapered bore is generally used if one wants to mount a bearing on a wide-tolerance shaft with a tapered adapter sleeve which usually has a taper of 1:12, or when the usage of a withdrawal sleeve is necessary.

In certain special applications (paper mill machines, rolling machines, etc.), the inner ring is mounted on a tapered seat of the shaft. This enables the clearance to be fixed very accurately by the displacement of the inner ring on the seat.

The normal 1:12 taper is designated by the suffix K.

The special 1:30 taper is designated by the suffix K30.

■ The 1:12 taper bore is produced in series on:

- Self-aligning ball bearings
- Spherical roller bearing.

However, in the 240xx and 241xx series, the 1:30 taper bore is used.

The dimensions of the tapered sleeves are indicated in the chapter *Tapered sleeves and Accessories*.

It should be noted that when a bearing is installed with a tapered sleeve, the shaft diameter is 5 mm less than the nominal bearing diameter, or a multiple of 5, depending on the size of the bearing.

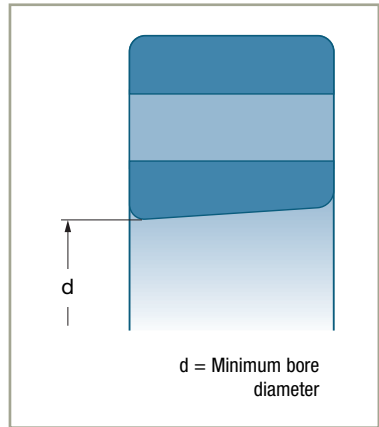

→ Special corners

In certain cases, a special corner radius can simplify and bring economies to the fitting process.

■ Increased corner fillet radius

An increased corner radius makes it possible, by doing away with the bearing shoulder ring, to increase shaft stiffness, to reduce the length of the shaft and to avoid stress concentrations.

Example: installation of bearings on wheel pins.

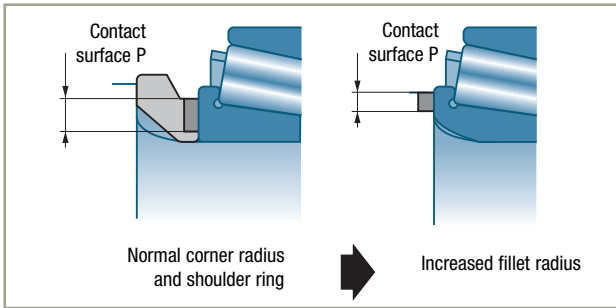

■ Reduced corner fillet radius

It allows smaller shoulder diameters to be accepted while maintaining an adequate contact surface. It is also beneficial if the shoulder is provided by a snap ring.

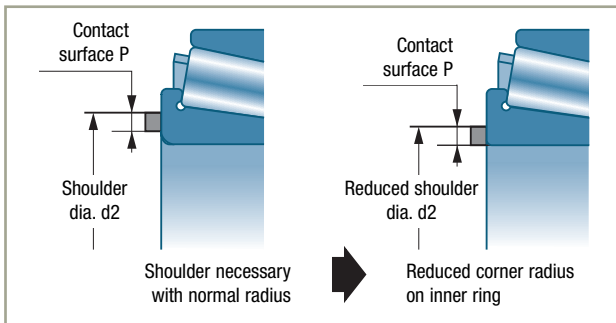

Bearing component variants *(continued)*

Definitions

■ Spherical outside diameter

For bearings designed to be mounted in self-aligning bearing units (or flanges) (single row radial-contact ball bearings).

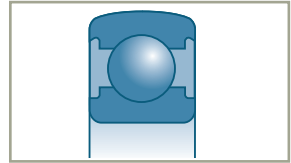

■ Increased thickness

This reinforcement enables the bearing to fulfill a roller function, with the outer ring rolling directly on a surface. The ring, with a straight or special profile, usually undergoes an appropriate heat treatment or surface treatment to reinforce its resistance to shocks and deformations.

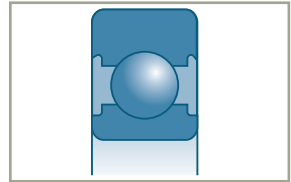

■ Special coatings

In certain applications (light loads, low speeds of rotation), over molding or the fitting of synthetic materials directly onto the outer ring allows the production of rollers of complex shape that function silently.

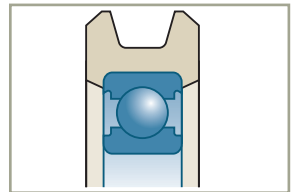

■ Lubrication groove and holes

This variant, designed to facilitate lubrication, is produced for the spherical roller bearings (suffix W33), with the exception of the 21300 series.

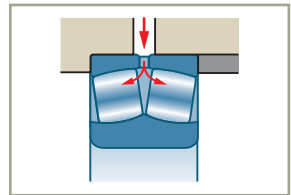

■ Snap ring groove

This groove is designed to accommodate a snap ring for axially positioning and locking the bearing.

The groove (suffix N) and the groove-snap ring system (suffix NR) are standard (ISO 464). The groove and installation dimensions are given in the "List of Standard Bearings". Snap rings are also available on double row shielded angular contact ball bearings.

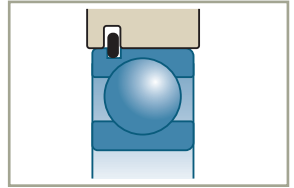
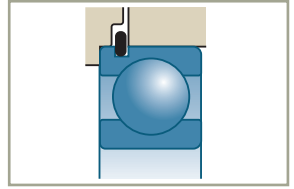

■ Flanged outer ring

This substitutes for the groove - snap ring system when the bearing ring is too narrow to have a groove.

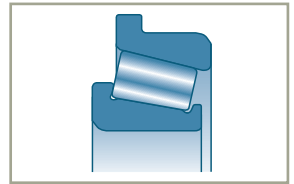

■ Reduced corner radius

The outer rings can be made with reduced corner radii in the same way as the inner rings and for the same reasons.

Bearing component variants *(continued)*

Other ring variants

The flexibility of the SNR ROULEMENTS machining resources enables the design of the bearing to be associated with surrounding parts in order to simplify fitting, reduce the number of parts, increase performance with:

- flanges and collars with smooth or threaded attaching holes,
- gear teeth cut in the rings,
- ...

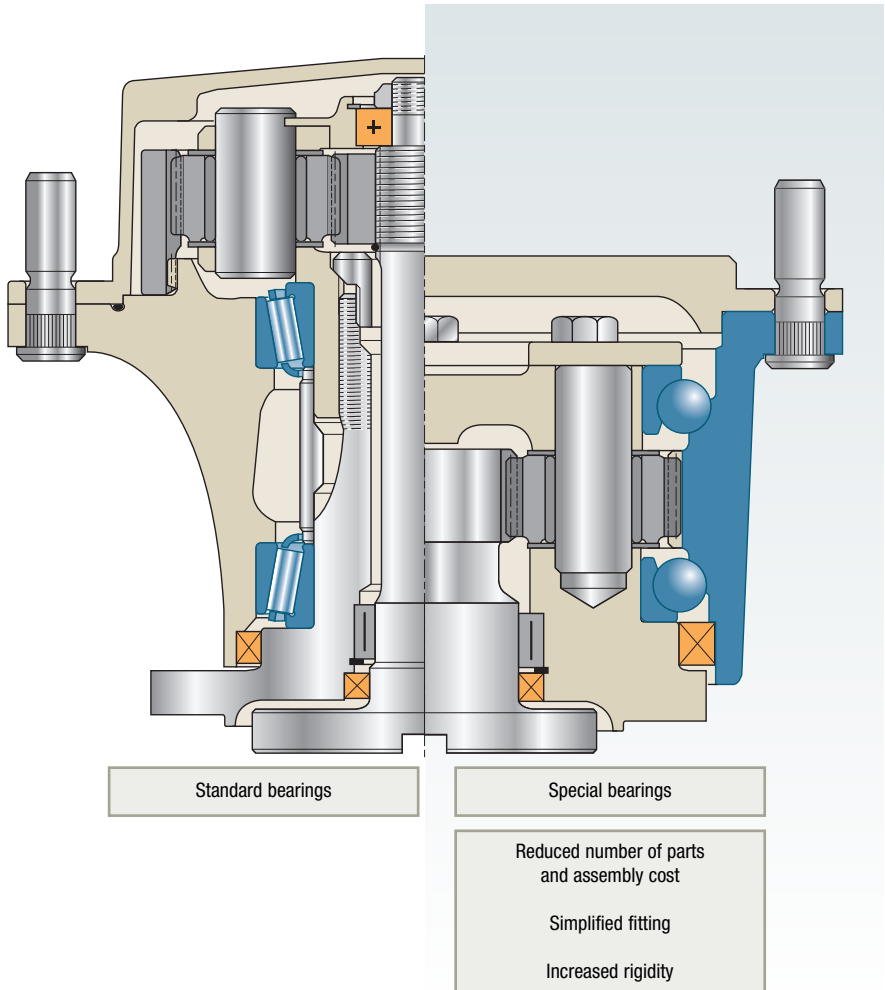

Cage

The function of the cage is to separate the rolling elements and keep them equally spaced to minimize friction and heating.

It also fulfils important complementary functions:

- keep the rolling elements assembled with one ring in detachable component bearings such as tapered and cylindrical roller bearings, self-aligning ball bearings, spherical roller bearings,
- help guide the rolling elements,
- ...

→ Materials

The cages are produced from several materials using various manufacturing processes. For each bearing there is a standard type of cage, which has always proved satisfactory in service, and is considered to be the best design for the majority of applications. The standard cage used for large bearings may differ from that for small bearings within the same series because of the different applications, manufacturing processes and costs. When a cage type becomes a standard cage, it is no longer identified by a specific suffix in the SNR bearing designation.

■ Molded synthetic material cages

The most commonly used material at present is polyamide 6.6 fiber glass reinforced.

These cages display interesting mechanical characteristics: low friction coefficient, elasticity, good impact and vibration resistance.

Furthermore, the molding process allows precise shapes that improve the guiding of the rolling elements. Due to the speed of changes in the world of synthetic materials, consult SNR for detailed information on the conditions of use of these cages.

The SNR standard sealed or shielded bearings can be equipped with this type of cage and compatible grease.

■ Cages made of stamped mild steel or brass sheets

In one or two pieces, riveted, fold clamped or welded together. These cages can be given a surface treatment to improve the friction coefficient.

■ Machined cages: phenolic resin, copper base alloys, aluminium alloys

For large-sized cages produced in small quantities, the machined brass cage is often standard, and in this case the bearing reference is always followed by the cage suffix (M, MA, or MB).

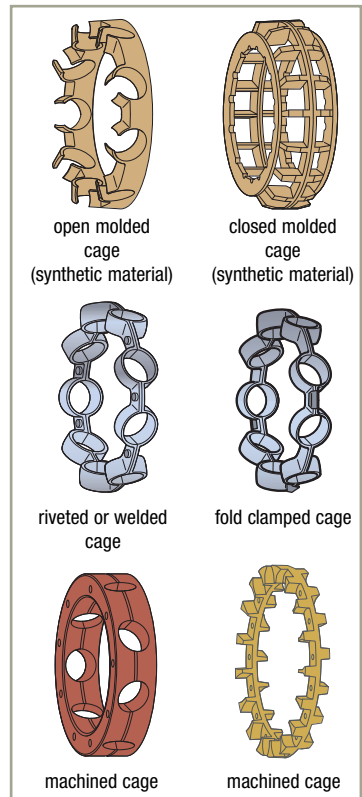

Bearing component variants *(continued)*

→ Cage centering

The cages can be centered:

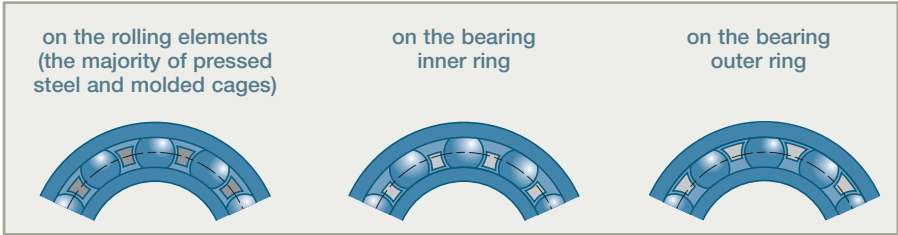

The centering choice depends on the bearing operating criteria: vibration, impacts, high speeds, speed variations,...

→ Choice of a special cage



The choice of a special cage will depend on the particular bearing operating criteria: Temperature, lubrication, vibration, sudden acceleration and deceleration, shaft-housing misalignment.

See the table on the opposite page.

In certain applications where a substantial increase in the dynamic loading capacity is needed (speed reducers, gearboxes, etc.) or static loading capacity (rollers, pulleys, etc.) special cageless bearings can be used.

It should be noted that the maximum speed for this type of bearing is lower than that of the corresponding standard bearing. Its lubrication demands a certain amount of attention due to the relative friction of the rolling elements.

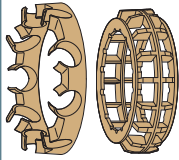

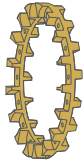
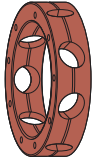
	Molded cage	Pressed steel or brass sheet cage	Machined brass cage	Machined phenolic resin cage
				
Maximum speed	<ul style="list-style-type: none"> ▶ That of the bearing 	<ul style="list-style-type: none"> ▶ That of the bearing 	<ul style="list-style-type: none"> ▶ Enables the maximum speed of the bearing to be increased 	<ul style="list-style-type: none"> ▶ Usually centered on a ring, which enables the maximum speed of the bearing to be increased
Temperature	<ul style="list-style-type: none"> ▶ Polyamide 6/6: +120°C/+248°F continuous service, +150°C/+302°F intermittently ▶ Other materials, consult SNR 	<ul style="list-style-type: none"> ▶ Does not limit the bearing operating temperature 	<ul style="list-style-type: none"> ▶ Does not limit the bearing operating temperature 	<ul style="list-style-type: none"> ▶ +110°C/+230°F max. in continuous service
Lubrication	<ul style="list-style-type: none"> ▶ Good friction coefficient ▶ Good behaviour when lubrication is deficient 	<ul style="list-style-type: none"> ▶ Metal-to-metal contact, therefore lubrication is important 	<ul style="list-style-type: none"> ▶ Low brass-to-metal friction coefficient 	<ul style="list-style-type: none"> ▶ Excellent coefficient of friction ▶ Cage impregnated with oil, optimum bearing lubrication
Resistance to vibration	<ul style="list-style-type: none"> ▶ Excellent behaviour - Lightness - Elasticity 	<ul style="list-style-type: none"> ▶ Restricted by: - mechanical strength - method of assembly - potential unbalance 	<ul style="list-style-type: none"> ▶ Excellent resistance ▶ Maintains despite the dynamic unbalance loads 	<ul style="list-style-type: none"> ▶ Good behaviour with cage centered on a ring ▶ Low inertia ▶ Good balance
Sudden acceleration and deceleration	<ul style="list-style-type: none"> ▶ Excellent behaviour - Lightness - Elasticity 	<ul style="list-style-type: none"> ▶ Risk of cage failure 	<ul style="list-style-type: none"> ▶ High mechanical strength but: - Lack of flexibility - High inertia 	<ul style="list-style-type: none"> ▶ Excellent behaviour due to: - Low inertia - Good mechanical strength
Misalignment between shaft and housing	<ul style="list-style-type: none"> ▶ Excellent behaviour - Elasticity 	<ul style="list-style-type: none"> ▶ Risk of cage failure 	<ul style="list-style-type: none"> ▶ Use not recommended 	<ul style="list-style-type: none"> ▶ Use not recommended
Remarks	<ul style="list-style-type: none"> ▶ Cage replacing the steel cage for many types of bearings 		<ul style="list-style-type: none"> ▶ High cost ▶ Usually reserved for highspeed and/or highprecision bearings 	<ul style="list-style-type: none"> ▶ High cost ▶ Usually reserved for high speed and / or high precision bearings

Shielding and sealing

The active parts of the bearing: rolling elements, raceways, cage, must always remain absolutely clean and well lubricated. Shielding and sealing serve to ensure the permanence of these two factors that are vital for the bearing life, by preventing contaminating agents from entering the bearing and by retaining the grease.

Two types of sealing devices are normally used with the bearings

■ Friction-free shields

These devices are based on the effect produced by a narrow space between rotating parts and fixed elements. These shielding devices produce virtually no friction and no wear. They are particularly suited to high speeds of rotation and high temperatures. Their efficiency can be reinforced by injecting grease into the bearing through the narrow gap between shield and inner ring.

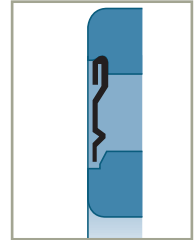

■ Friction seals (contact)

The seal exerts pressure on the conjugate surface, usually by means of a lip. This prevents the ingress of impurities and moisture and/or loss of lubricant.

The pressure can be created:

- either by the load exerted by a spring incorporated at the end of the seal,
- or by the elasticity of the seal material and appropriate fitting of the lip on its contact surface.

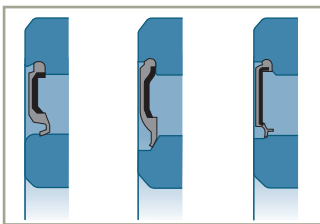
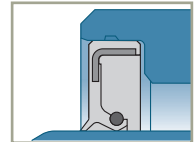
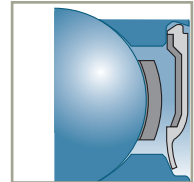

Standard seals

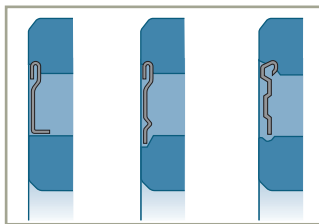

Shields

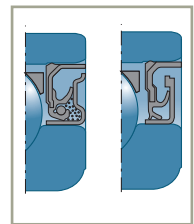





Special seals

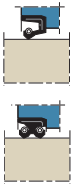

SNR proposes a wide and diverse range of shields and seals, either fully integrated in the bearing or reinforced by a front lip. Depending on the applications, these devices can be replaced or reinforced by a protection mechanism that is independent of the bearing.

Shielding and sealing devices external to the bearing

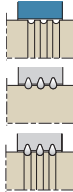
The shielding or sealing devices integrated in the bearings can be replaced or reinforced by a protection independent of the bearing, depending on the applications. Protection devices that are independent of the bearing may be with or without friction. They may be combined for increased protection.

		Devices with friction				Devices without friction		
		Radial effect		Axial effect				
Type								
		Felt	Metal-plastic seal	Mechanical seal	Front-lip seal	Grooves	Labyrinth seal	Shield
Maximum linear speed (m/sec)		4	<ul style="list-style-type: none"> ▶ Acrylic nitrile NBR: 15 ▶ Polyacrylate ACM: 18 ▶ Fluoroelastomer FKM: 20 	16	7			
Maximum service temperature °C (°F)		-40 +110 (-40) (+230)	<ul style="list-style-type: none"> ▶ Acrylic nitrile NBR -30 (-22)+110 (230°) ▶ Polyacrylate ACM -10 (14)+170 (+338) ▶ Fluoroelastomer FKM -40 (-40)+200 (+392) 	-40 +150 (-40) (+302)	-40 +110 (-40) (+230)			
Maximum misalignment		0.01 rad 0.5°	0.01 rad 0.5°	0.01 rad 0.5°	0.02 rad 1°	0.001 rad 0.06°	0.001 rad 0.06°	0.001 rad 0.06°
Seal seat	Hardness	Min 30HRc or 300 HV	Min 40HRc or 450 HV	Seal integrated in seal				
	Surface condition (seating) (Ra max)	3.2 µm	0.8 µm		3.2 µm	0.8 µm (shaft)	0.8 µm (shaft)	
Particular points		<ul style="list-style-type: none"> ▶ Soak the felt in oil at 80°C (176°F) before fitting ▶ Standard grooves 	<ul style="list-style-type: none"> ▶ Provide a chamfer on the shaft to ease entry of the lips ▶ Grease seal and seals before fitting 	<ul style="list-style-type: none"> ▶ This seal can withstand relatively high pressures 	<ul style="list-style-type: none"> ▶ The use of fluoroelastomer seals increases the operating temperature capability and speed range 	<ul style="list-style-type: none"> ▶ 3 grooves minimum ▶ Clearance between shaft and housing of 0.3 to 0.5 mm for Ø < 50 ▶ 0.8 to 1.2 mm for Ø > 50 ▶ Axial clearance of 1 to 2 mm for Ø < 50 ▶ 2 to 4 mm for Ø > 50 		
Applications		<ul style="list-style-type: none"> ▶ Split pillow blocks 	<ul style="list-style-type: none"> ▶ General 	<ul style="list-style-type: none"> ▶ Fluid-tight 	<ul style="list-style-type: none"> ▶ Reinforced sealing against contaminants 	<ul style="list-style-type: none"> ▶ Precision component ▶ High speed ▶ Poorly contaminated environments 	<ul style="list-style-type: none"> ▶ Precision component ▶ High speed ▶ Poorly contaminated environments 	<ul style="list-style-type: none"> ▶ Used to reinforce another type of sealing against contamination ▶ Acts by centrifuging
Recommended lubrication		<ul style="list-style-type: none"> ▶ Grease 	<ul style="list-style-type: none"> ▶ Grease ▶ Oil 	<ul style="list-style-type: none"> ▶ Grease ▶ Oil 	<ul style="list-style-type: none"> ▶ Grease 	<ul style="list-style-type: none"> ▶ Grease ▶ Oil 	<ul style="list-style-type: none"> ▶ Grease ▶ Oil 	

Shielding and sealing (continued)

Other types of seals

Other types of sealing can be integrated in the bearing.

For many applications, integrating the seal saves space and weight, thereby reducing the cost of the sealing function.

Some examples:

■ Radial sealing ring with spring

Sealing rings with radial lips equipped with a spring suit numerous industrial applications. They are particularly suited to those requiring oil sealing, but can also be used with greased bearings.

This type of seal can also be equipped with a lip protecting against dust and external dirt.

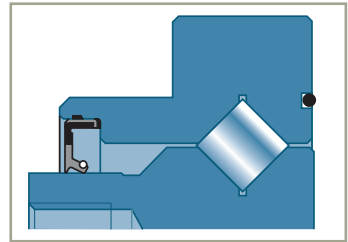

■ O-ring

O-rings can be integrated in the bearing to ensure static sealing against oil or grease.

■ Linear seal

Seal formed by one or more lips in non-reinforced elastomer. The seal is produced by the meter and can be adapted to bearings of different diameters.

This type of seal is well suited to greased bearings.

Used extensively in robotics applications.

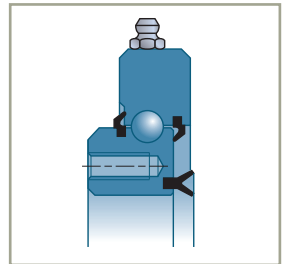

■ Mirror seal

In all applications exposed to high wear stresses from mud, sand or dust, it is possible to integrate a mirror seal.

These seals are made by two rubbing metal rings mounted elastically with two O-rings.

This type of sealing is particularly suitable for civil engineering applications (caterpillar vehicles, sand preparation plants, etc.) and mine working machines.

